

146-153 QuantumOne™ Round Front, Vitreous China, Two-Piece Toilet



Features

- High efficiency (HET) pressure assist vessel
- 1.0 gpf / 3.8 lpf ultra-low water consumption
- SAVES up to 40% more water than conventional 1.6 gpf flushing systems
- Round front bowl
- 12" rough-in
- Trip levers
 - Model 45 left hand, chrome-plated metal trip lever
 - Model 47 chrome-plated push button actuator
 - Model 49 right hand, chrome-plated metal trip lever
- 2-1/8" glazed trapway
- The Mansfield® limited lifetime warranty (china)
- Ten year limited vessel warranty
- Available in White and Standard Colors: Biscuit and Bone





Round Front





Model 146-153
Toilet seat not included

Components

Model #	Description	Approximate Weight
146-153	Round front, pressure-assist, two-piece toilet. Less toilet seat and supply. Specify color.	 
146	Round front toilet bowl only. Less toilet seat. Specify color.	
153RH	Same as model 153, except with right hand, chrome-plated, metal trip lever.	
154	Same as model 153, except with push button actuator.	

Other Options:

153	Same as model 154, except with left hand, chrome plated, metal trip lever.	  
-----	--	---





MADE IN USA

146-153 QuantumOne™

Round Front, Vitreous China, Two-Piece Toilet



Specifications

Model #	Description	Codes/Standards
146-153	Round front (1.0 gpf/3.8 lpf) two-piece toilet	  

Specification	Description	Specification	Description
Material	Vitreous China	Trap Diameter	2-1/8"
Water Pressure Range	35 to 80 PSI	Trap Seal	2-3/4"
Flush System	Flushmate IV™ Pressure assist vessel	Rough-in	12"
Water Usage	1.0 gpf / 3.8 lpf	Shipping Weight	Model 146 - 51 lbs. (23.13 kg)
Water Surface Area	9-3/4" X 11-1/2"		Model 153/153RH/154 - 41 lbs. (18.6 kg)
MaP Rating	1000 grams	Warranty	Vitreous China - Limited Lifetime Tank Trim - Limited One Year

Technical Information

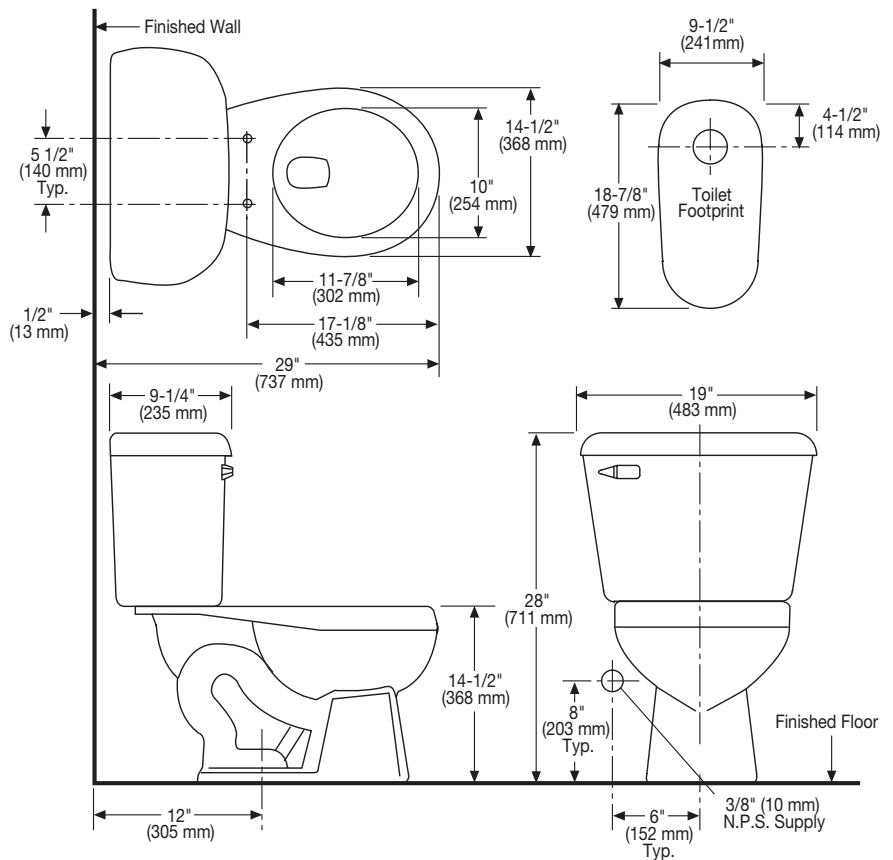

See our complete line of acrylic and vitreous china bathroom fixtures, plastic tank trim and plumbing products.

These dimensions are nominal and subject to change without notice.

Fixture performance and specifications meet or exceed ASME A112.19.2-2008/CSA B45.1-08 standards, and other state and local codes.



MADE IN USA