



Tresham® Rectangle

Drop-in Bathroom Sink
K-2991-4

Features

- 4-inch center faucet holes.
- Rectangular basin with raised rim.
- Overflow drain.
- Coordinates with other products in the Tresham collection.
- 4" centerset faucet drilling

Material

- Vitreous china.

Installation

- Drop-in

Recommended Products/Accessories

K-8998 P-Trap



ADA

Codes/Standards











ASME A112.19.2/CSA B45.1
ADA
ICC/ANSI A117.1

KOHLER® One-Year Limited Warranty

See website for detailed warranty information.

Available Colors/Finishes

Color tiles intended for reference only.

Color	Code	Description
	0	White
	96	Biscuit
	47	Almond
	NY	Dune
	95	Ice™ Grey
	G9	Sandbar
	33	Mexican Sand™
	K4	Cashmere
	58	Thunder™ Grey
	7	Black Black™

1-800-4KOHLER (1-800-456-4537)

Kohler Co. reserves the right to make revisions without notice to product specifications.

For the most current Specification Sheet, go to www.kohler.com.

9-7-2019 09:10 - US/CA

THE BOLD LOOK
OF **KOHLER**®

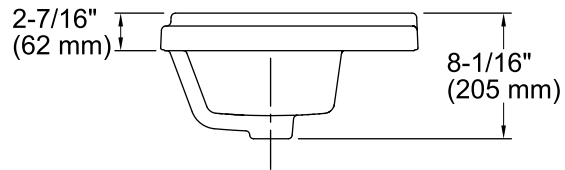
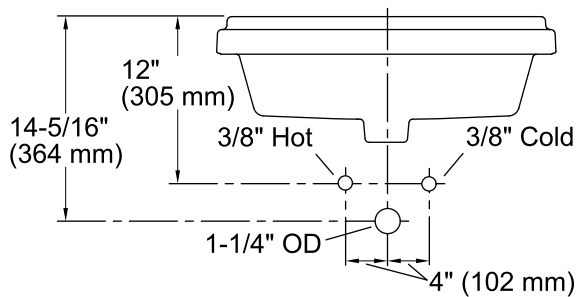
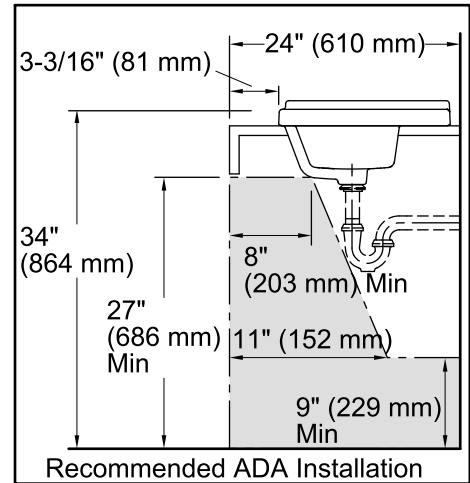
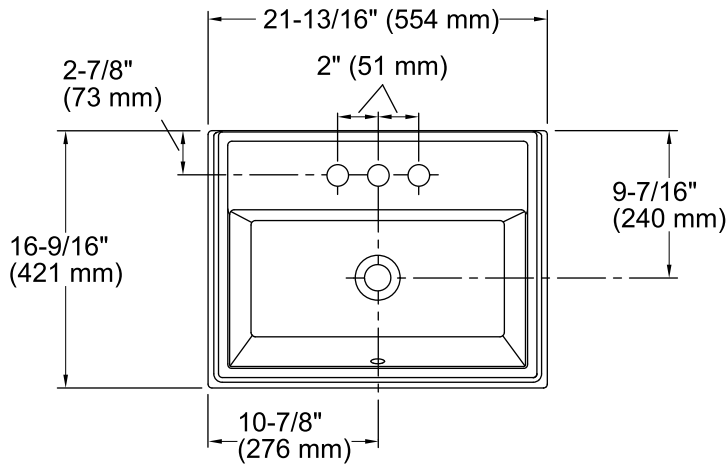

Technical Information

All product dimensions are nominal.

- Bowl configuration: Single
- Installation: Drop-in
- Bowl area (Only): Length: 19-13/16" (503 mm)
Width: 10-3/16" (259 mm)
Water depth: 6-1/16" (154 mm)
- Number of deck holes: 3
- Faucet hole spacing: 4" (102 mm)
- Faucet hole(s): 1-1/4" (32 mm)
- Drain hole: 1-3/4" (44 mm)
- Template: 1162721-7, required, included

Notes

Install this product according to the installation instructions.

NOTICE: Countertop manufacturer or cutter must use the cut-out template provided with the product, or a current one provided by Kohler Co. (call 1-800-4KOHLER). Kohler Co. is not responsible for cutout errors when the incorrect cut-out template is used.

ADA compliant when installed to the specific requirements of these regulations.