

JASON[®]

HYDROTHERAPY

8328 MacArthur Dr. • North Little Rock, AR 72118
 501.771.4477 • Fax: 501.771.2333
 Customer Service: 800.255.5766
 www.jasoninternational.com

Designer Collection Specifications

LC635

AirMasseur[®] -Soaking

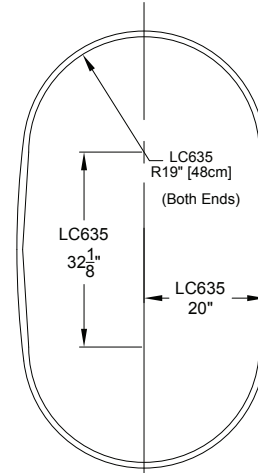
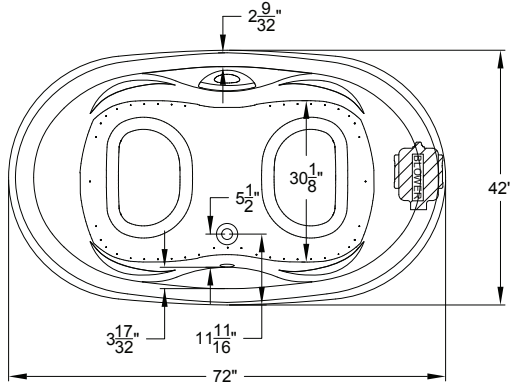

Drop In Hole Size

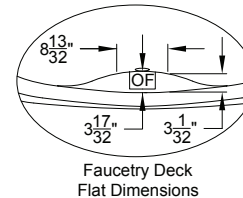
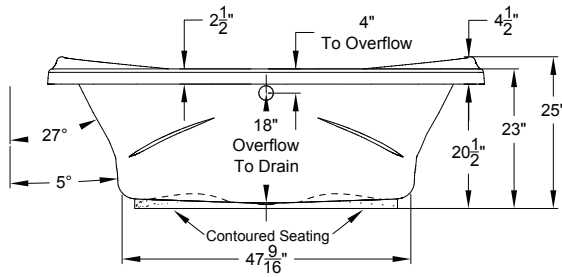

Faucetry Deck Flat Dimensions

Patents recieved or pending.



Note: Dimensional Tolerances: ±1/4"

- Drop-in-Hole Size:** See Diagram
- Operating Capacity:** 66 Gal.
- Overflow Capacity:** 86 Gal.
- Floor Loading / sq.ft. (A/S):** 55.8 / 54.7 lbs.
- Carton Wt. (Air/Soaking):** 153 / 136 lbs.
- Cube:** 51.8 ft.³

Note: The blower extends approximately 1" past the end radius of the bath. This requires angling the bath into the drop-in hole.

Construction: Fiberglass reinforced acrylic bath with Level Form™ full-support base.

We provide products listed with Intertek ETL SEMKO (Edison Testing Laboratories) U.S. and Canadian and with International Association of Plumbing and Mechanical Officials (IAPMO). Consult factory with your listing requirements.

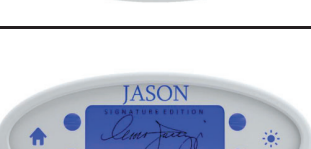
Standard		A 120V system that includes a 1HP, variable speed blower with integral heater; automatic purge cycle; an electronic control that operates blower and blower speed for continuous, wave, or massage pulse modes; and a 20-minute timer.
Premier		A 120V system that includes a 1HP, variable speed blower with integral heater; automatic purge cycle; (2) Chromatherapy mood lights; Automatic Ozone System; an electronic control that operates blower and blower speed for continuous, wave, or massage pulse modes; and a 20-minute timer.
Signature		A 120V system that includes a 1HP, variable speed blower with integral heater; automatic purge cycle; (2) Chromatherapy mood lights; Automatic Ozone System; a digital control with LCD display; low water level and temperature sensors; enhanced user control options; a 20-minute timer; and Bluetooth Sound Immersion System. Control keypad operates blower and blower speed for continuous, wave, or pulse massage modes, LED Chromatherapy lights, and shows equipment status, water temperature, and time remaining.