

**Talis S**  
**HighArc Kitchen Faucet, 2-Spray Pull-Down, 1.75 GPM**  
 Finishes : **steel optic** Part no. : **72813801**



**Description**

**Features**

- Swivel range 110° / 150°
- Laminar and needle spray
- Toggle spray diverter
- MagFit magnetic sprayhead docking
- Single-hole installation
- Flow: 1.75 GPM (6.6 L/Min)
- Ceramic cartridge
- 3/8" connections
- Integrated double backflow prevention

**Item details**

List Price \$ 700.00

**Technology**



**Compliance**



**Product image**



**Scale drawing**

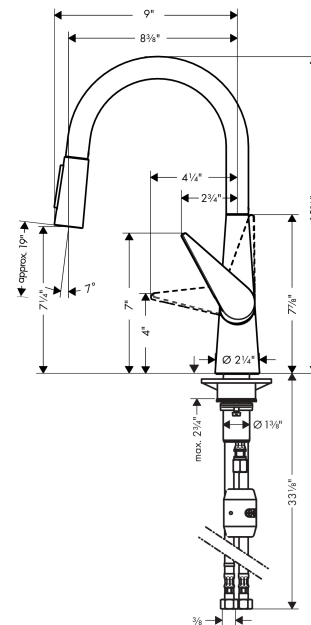

**Talis S**  
**HighArc Kitchen Faucet, 2-Spray Pull-Down, 1.75 GPM**  
 Finishes : **steel optic**    Part no. : **72813801**



Exploded drawing

Year of production: >01/17

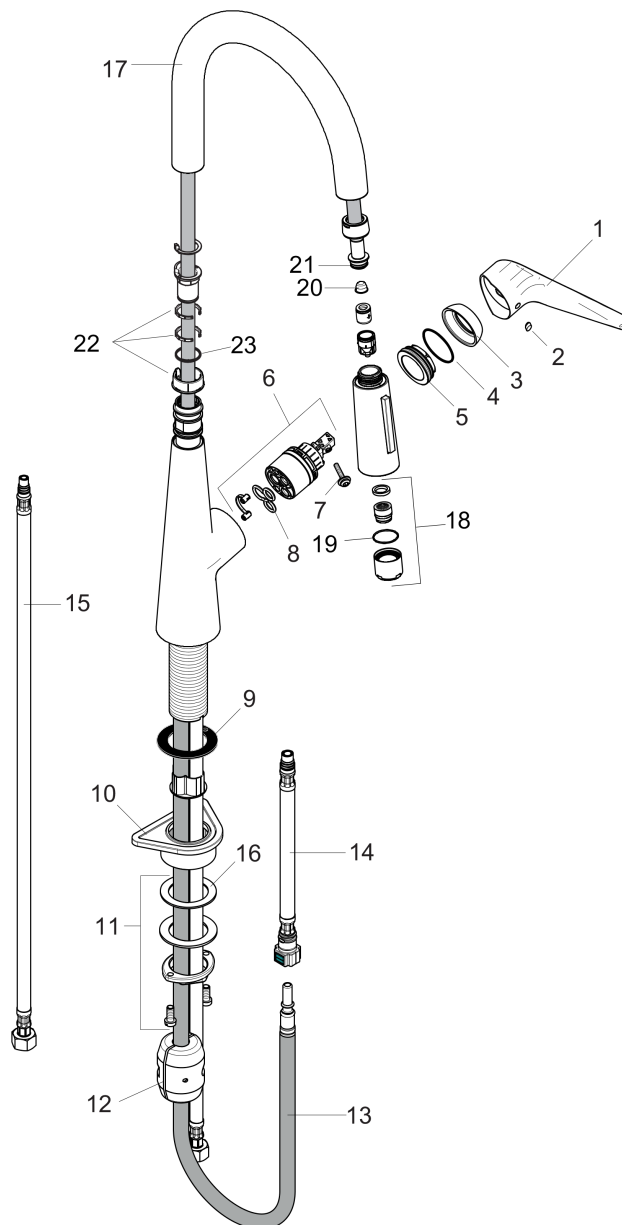

**Talis S**  
**HighArc Kitchen Faucet, 2-Spray Pull-Down, 1.75 GPM**  
 Finishes : **steel optic** Part no. : **72813801**



## Spare parts list

Year of production: >01/17

Pos.	Description	Part no.	Price	PU
1	handle	92581000	-	1
2	screw cover	96338000	-	1
3	flange	95498800	-	1
4	O-Ring 32x2	98193000	-	1
5	nut	97209000	-	1
6	cartridge, assy	92730000	-	1
7	locking screw for handle	95140000	-	1
8	seal	95008000	-	1
9	seal	92582000	-	1
10	support	97523000	-	1
11	fixing set (Ø 34)	95049000	-	1
12	weight	98551000	-	1
13	hose 1,50 m	88624000	-	1
14	connection hose 600 mm M10x1	95561000	-	1
15	connection hose 35½" M8x0,75 3/8"	96316001	-	1
16	lever collar	97548000	-	1
17	spout cpl.	92731800	-	1
18	aerator laminar M22x1 (15 l/min)	95909000	-	1
19	O-ring 20x1	98140000	-	1
20	filter	97735000	-	1
21	O-ring 11x2	98127000	-	1
22	set of lever collars	98365000	-	1
23	O-ring 21x2,5	98211000	-	1