

Metropol
Single-Hole Faucet 110 Select, 1.2 GPM
 Finishes : **brushed nickel** Part no. : **32571821**



Description

Features

- Aerated spray
- Flow: 1.2 GPM (4.5 L/Min)
- Select cartridge for easy, intuitive operation: Push handle to turn water on and off, and turn to adjust temperature

Item details

List Price \$ 479.00

Technology



Compliance



Product image



Scale drawing

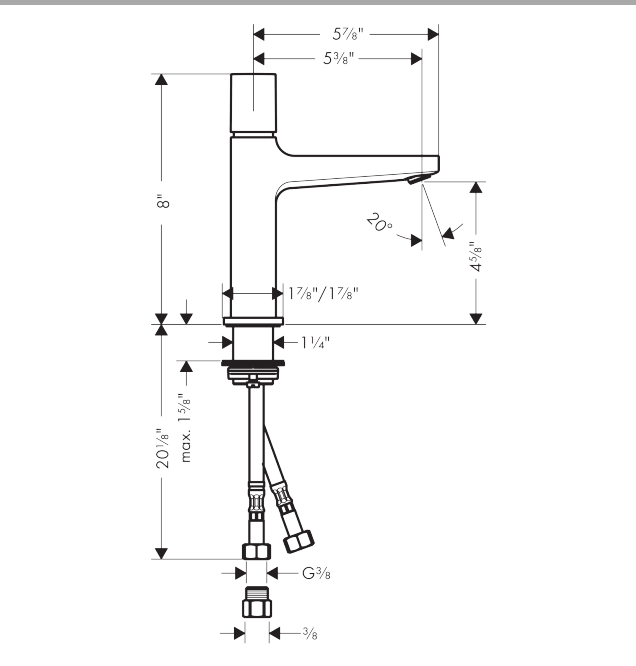

Metropol
Single-Hole Faucet 110 Select, 1.2 GPM
 Finishes : **brushed nickel** Part no. : **32571821**



Exploded drawing

Year of production: >01/18

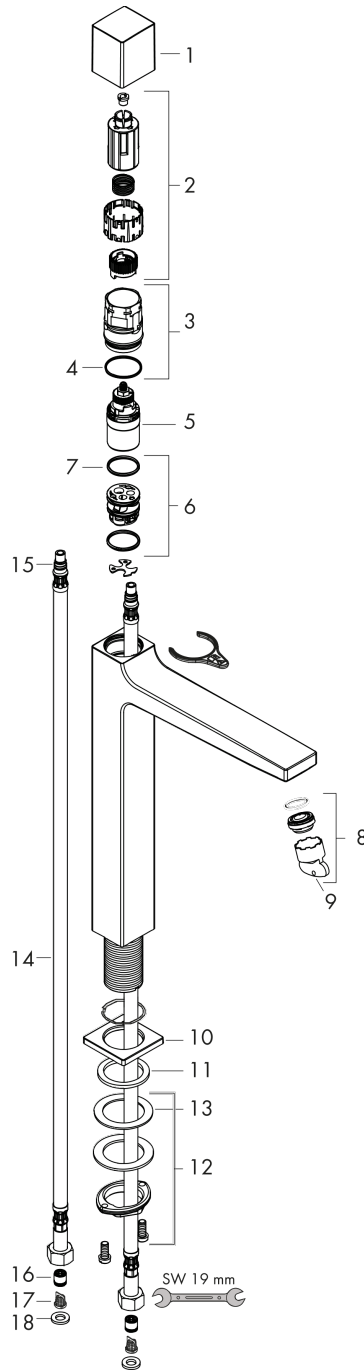

Metropol
Single-Hole Faucet 110 Select, 1.2 GPM
 Finishes : **brushed nickel** Part no. : **32571821**



Spare parts list

Year of production: >01/18

Pos.	Description	Part no.	Price	PU
1	handle	93070820	-	1
2	adapter for handle	92526000	-	1
3	nut	92528000	-	1
4	O-ring 27x1,5	92527000	-	1
5	cartridge, assy	92529000	-	1
6	adapter for cartridge	98866000	-	1
7	O-ring 23x2	98398000	-	1
8	aerator M24x1 (4,5 l/min)	93202000	-	1
9	service tool	95661000	-	1
10	escutcheon	93048820	-	1
11	flat seal	98749000	-	1
12	fixing set (Ø 32)	13961000	-	1
13	lever collar	97548000	-	1
14	connection hose 600 mm M8x0,75 G3/8	92629000	-	1
15	O-ring 7x1,5	98422000	-	1
16	non return valve DW 10	96456000	-	1
17	filter	92532000	-	1
18	sealing set	92533000	-	1
a	adapter for connection hose	88802000	-	1