

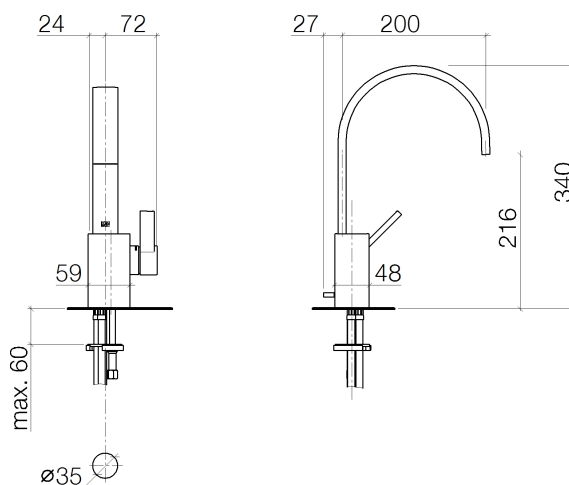

### Product specifications

- **200 mm projection**
- fixed spout
- rectangular, air-enriched flow
- height of mixer 340 mm
- height up to aerator 216 mm
- hole diameter 35 mm
- 2x screw-in M 10 x 1 pressure hose, leak-tested
- max. flow 6 l/min
- lead-free



### Surfaces

- |                 |             |
|-----------------|-------------|
| • chrome        | 33501782-00 |
| • platinum matt | 33501782-06 |
| • platinum      | 33501782-08 |
| • Cyprum        | 33501782-49 |

**Exploded assembly drawing**

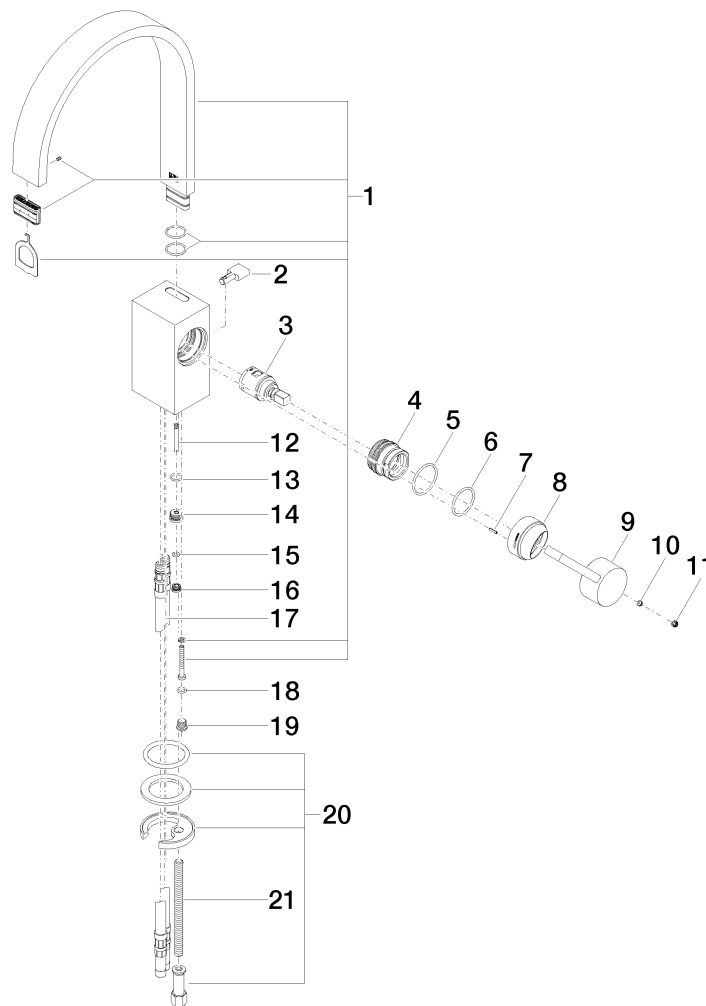

**Order quantity**

<b>No.</b>	<b>Article number</b>	<b>Name</b>	<b>Installation quantity</b>
1	90282215201ff	spout	1
2	092078032ff	handle	1
3	9015050420090	cartridge	1
4	09240428890	nut	1
5	09141013790	seal	1
6	09141006390	seal	1
7	09311115290	pin	1
8	092830028ff	cover	1
9	092078057ff	handle	1
10	09311106390	pin	1
11	09312010990	plug	1
12	093109080ff	pull-rod	1
13	09141004290	seal	1
14	092404289ff	nipple	1
15	09141016690	seal	1
16	09240429090	nipple	1
17	0430040160090	hose	2
18	09141013290	seal	1
19	09312002710ff	plug	1
20	0430110387590	fixing set	1
21	09311101290	pin	1
22	04110100100ff	pop-up waste	1

**Flow rate chart**

